

**JUKI**

# LU-2200N Series

High-speed, Unison-feed, Lockstitch Machine  
with Vertical-axis Large Hook and Automatic Thread Trimmer



*high speed*

*powerful*

**VIET LE CO., LTD.**  
Sewing & Textile machines and Parts

**HOTLINE: 0982 085 899**

*high performance*

# LU-2200N Series

Capabilities for sewing car seats have been  
significantly improved.

# Efficiency of feed and sewing capabilities for supporting sewing performance at a higher speed of 3,500sti/min



High-speed, 1-needle, Unison-feed, Lockstitch Machine with Vertical-axis Large Hook and Automatic Thread Trimmer

**LU-2210N-7** 1.6 fold-capacity hook

**LU-2210W-7** Double-capacity hook

The machine demonstrates outstanding performance when sewing heavy materials, with its "high-quality consistent sewing capabilities", as well as with its remarkably powerful feed.

**VIET LE CO., LTD.**  
Sewing & Textile machines and Parts

**HOTLINE: 0982 085 899**



High-speed, 2-needle, Unison-feed, Lockstitch Machine with Vertical-axis Large Hook and Automatic Thread Trimmer

**LU-2260N-7** 1.6 fold-capacity hook

**LU-2260W-7** Double-capacity hook

The machine is the standard type 2-needle machine, which is essential for topstitching processes. As with the aforementioned 1-needle machine, the standard 2-needle machine has an outstanding high-speed capability and promises consistent sewing performance.

# 3500sti/min

## Higher lift of the presser foot

- The machine is provided as standard with a pneumatic auto-lifter.
- The high, 16mm presser foot lift enables easy material handling.



## The walking foot and presser foot's alternating vertical movement can be set and changed with ease.

- The vertical strokes of the presser foot and walking foot (alternating vertical movement) can be easily changed using a large dial mounted on the top surface of the machine head.
- In addition the sewing speed is automatically adjusted with the set value. With this feature, ideal sewing conditions are maintained at all times.



**VIET LE CO., LTD.**

Sewing & Textile machines and Parts

**The machine promises outstanding adaptability and ease of use with its full-fledged functions.**

## The highly efficient vertical-axis 1.6 fold-capacity hook is provided as standard.

- With the adoption of this vertical-axis 1.6 fold-capacity hook, the frequency of bobbin thread winding is reduced, promising sewing work of increased efficiency.



Bobbin for vertical-axis 1.6 fold-capacity hook

Bobbin for standard hook

## Instantaneous change-over device for the alternate vertical movement amount (DL device) is provided as standard.

- The alternate vertical movement amount can be instantaneously maximized in a process for sewing a hard-to-feed part of material, such as a multilayered part, finishing with beautiful seams free from stitch gathering.
- The machine is provided with both a hand switch and knee switch.

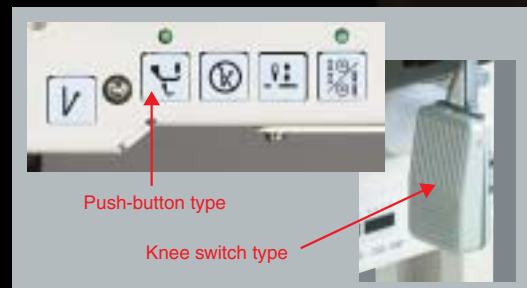

Push-button type

Knee switch type

**HOTLINE: 0982 085 899**



**High-speed, 1-needle, Unison-feed, Lockstitch Machine with Vertical-axis Large Hook and Automatic Thread Trimmer**

**LU-2212N-7** 1.6 fold-capacity hook / 2-pitch dial type

One of two different stitch lengths can be selected according to the application. The stitch length can be instantaneously changed over by pressing the stitch selector switch mounted on the lower part of the machine arm.

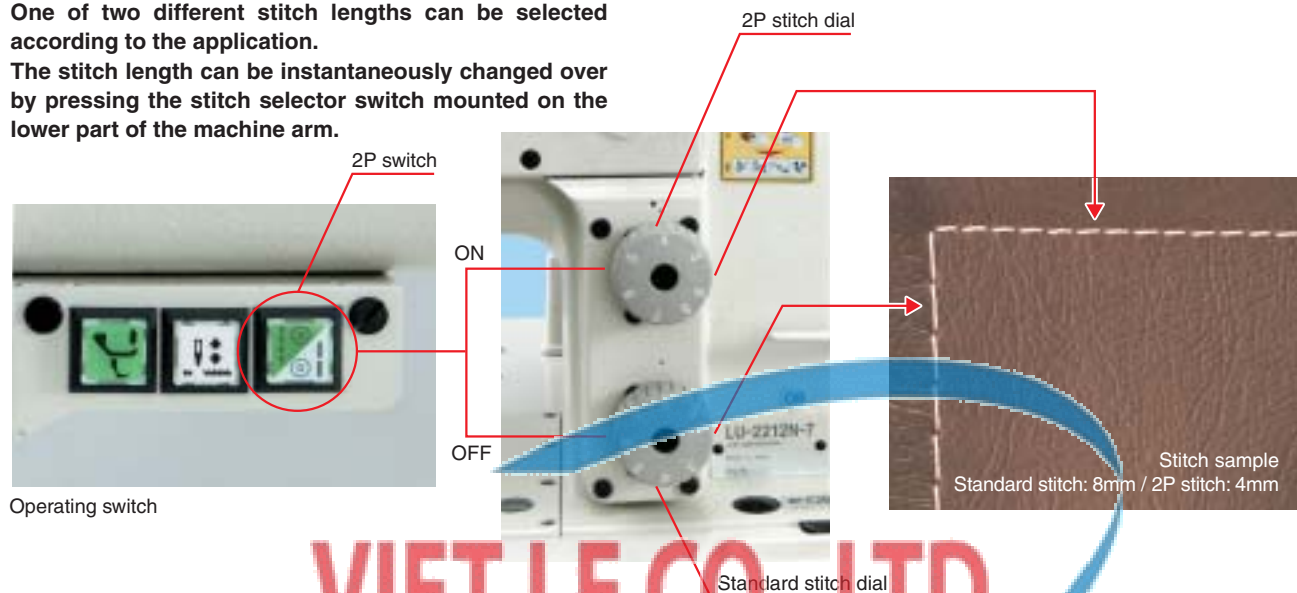

**VIET LE CO., LTD.**  
Sewing & Textile machines and Parts

**High-speed, 1-needle, Unison-feed, Lockstitch Machine with Vertical-axis Large Hook and Automatic Thread Trimmer**

**LU-2220N-7** 1.6 fold-capacity hook / 2-pitch dial / Shorter thread remaining type

Thread nipping work required at the beginning and end of sewing is reduced. This is a high-performance machine which contributes to both increased productivity and improved quality for sewing car seats. Frequency of the use of scissors by the operator is reduced, thereby helping prevent the material from being damaged.

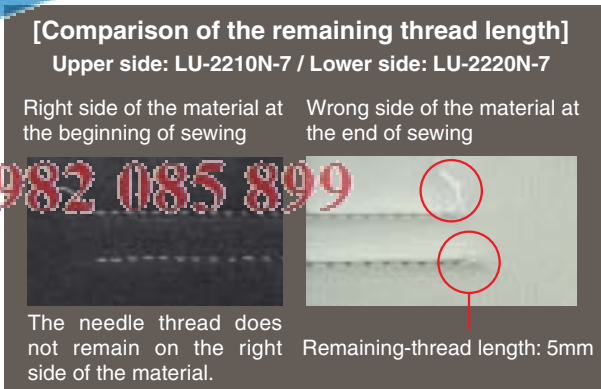

**HOTLINE: 0982 085 899**



Needle thread clamping at the beginning of sewing can be turned ON/OFF.

The thread trimming mechanism has been totally redesigned to shorten the length of thread remaining on the material at the end of sewing down to 5 mm.











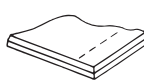







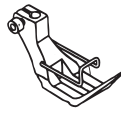

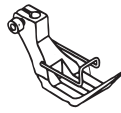
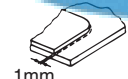

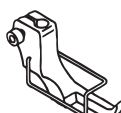
## ATTACHMENTS

Description	Part No.
Suspended ruler (asm.) H152	MAH-152010A0
Suspended ruler mounting base (asm.)	107-35868

\*Suspended ruler mounting base (asm.) is required to mount the suspended ruler.

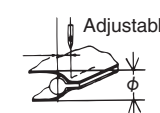
## INTERCHANGEABLE GAUGE PARTS

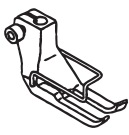
[LU-2210N-7] [LU-2210W-7] [LU-2212N-7] [LU-2220N-7]

Application	Walking foot			Presser foot		
	A	Standard		A	Standard	
<b>Standard</b> 	107-11653		A	Standard	107-12552	
<b>For material with overlapped section</b> Allows the smooth feed of multi-layered portions of the material 			K	Standard (pressing face is reduced)	107-58456	
			B	For material with overlapped section	107-12651	
<b>For light-weight sponge</b> Used for resilient materials including sponge 	107-11752		C	For urethane	107-12750	
<b>For heavy-weight sponge</b> Used for more resilient materials Thick 			B	For urethane	107-12750	
<b>Right single-sided presser</b> Used for sewing material edges  1mm	107-11851		C	Right single-sided	107-12859	
<b>Left single-sided presser</b> Used for sewing material edges  1mm			D	Left single-sided	107-12958	
<b>For piping</b> Used for the general piping process 	107-45354 107-45453 107-45552 107-45651		E~H	For piping	107-47350 107-47459 107-47558 107-47657	
<b>For piping</b> The position of the needle can be adjusted according to the pipe to be sewn  Adjustable			J~M	Adjustable presser for piping		
<b>Wide type</b> To be used when a sewing product cannot be smoothly fed 	(special order) 107-12057		(special order) 107-13055			
<b>Without groove</b> To be used when the thread can not be grasped at the sewing start 	107-12354		A or K or B			

## INTERCHANGEABLE GAUGE PARTS

### ●Throat plate

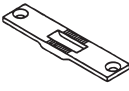
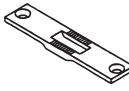
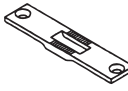
For LU-2210N-7 / 2212N-7		For LU-2220N-7*
		
107-01704	107-02009	400-58071
Standard	Wide type (special order)	Standard





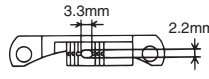
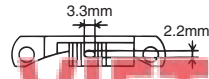
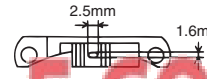
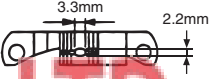
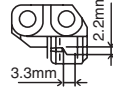
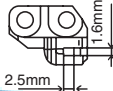
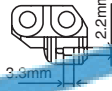
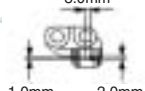
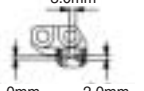

\*Throat plate (400-58071) for the LU-2220N-7 is also applicable to the LU-2210N-7/LU2212N-7.

### ●Feed dog

For LU-2210N-7 / 2212N-7				
				
107-17106	107-17205	107-17304	107-39001	
S Standard (thread groove width: 1.0mm)	A Without groove (To be used if the needle thread and bobbin thread do not meet at the beginning of sewing)	B For thin thread (thread groove width: 1.0mm)	Wide type (special order)	
For LU-2220N-7				
				
400-58070	400-64353	400-62827	400-81022	400-83237
S Standard (thread groove width: 1.0mm)	B For thin thread (thread groove width: 1.0mm)	C For thick thread (thread groove width: 3.0mm)	For needling curved prevention (Nm 30)	For needling curved prevention (Nm140)

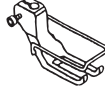
HOTLINE: 0982 085 899

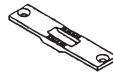
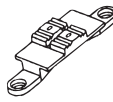
### [LU-2260N-7] [LU-2260W-7]

Needle gauge	Gauge* set No.	Needle clamp	Presser foot	Walking foot	Throat plate	Feed dog	Slide plate*	
							Left	Right
								
6mm	107-84650	107-77654	107-81656	107-83157	107-84601	107-80104	107-86309	107-01803
8mm	107-84759	107-77753	107-81755	107-83256	107-84700	107-80203		
10mm (standard)	107-84858	107-77852	107-81854	107-83355	107-84809	107-80302	107-86408	107-86002
12mm	107-84957	107-77951	107-81953	107-83454	107-84908	107-80401		
20mm	107-85350	107-78355	107-82357	107-83850	107-85301	107-80807	107-86507	107-86101

Note) Applicable to gauges "4 mm to 36 mm" (LU-2260N-7) and "4 mm to 30 mm" (LU-2260W-7).

Any gauges other than the forementioned are available through special order.

\*The right and left slide plates are not included in the parts represented by the gauge set number.

WHEN YOU PLACE ORDERS

Feed dog	Code
With groove (standard)	S
Without groove (excluding LU-2220)	A
For thin thread	B
For thick thread (LU-2220 only)	C

Option	Code
Not provided	Z
With bobbin thread remaining amount detecting device	A*

Machine head	Code
1-needle	10
1-needle / 2-pitch dial type	12
1-needle / 2-pitch dial / Shorter thread remaining type	20

DL device	Code
Not provided	Z*
Provided with DL function / Push-button type	A*
Provided with DL function / Knee switch type	B

\*AE-16 is applicable to LU-2210 and LU-2212 (only with a 1.6 fold-capacity hook).

\*AE-17 is applicable to LU-2220.

\*Z and A are only applicable to LU-2210.

LU22 70B

Hook	Code
1.6 fold-capacity hook	N
Double-capacity hook	W

\*For the LU-2212 and LU-2220, only 1.6-fold hooks are applicable.

Walking-foot	Code
Standard	A
For urethane	B
Right single-sided	C
Left single-sided	D
For piping (ø3)	E
For piping (ø4)	F
For piping (ø5)	G
For piping (ø6)	H
Adjustable type for piping (ø3)	J
Adjustable type for piping (ø4)	K
Adjustable type for piping (ø5)	L
Adjustable type for piping (ø6)	...

Presser foot	Code
Standard	A
For material with overlapped sections	B
For urethane	C
Right single-sided	D
Left single-sided	E
For piping (ø3)	F
For piping (ø4)	G
For piping (ø5)	H
For piping (ø6)	J
Pressing face is reduce	K

HOTLINE: 0982 085 899

LU2260 70B

Hook	Code
1.6 fold-capacity hook	N
Double-capacity hook	W

Needle gauge	Code
6mm	B
8mm	C
10mm (standard)	D
12mm	E
20mm	J

DL device	Code
Not provided	Z
Provided with DL function / Push-button type	A
Provided with DL function / Knee switch type	B

Option	Code
Not provided	Z
With bobbin thread remaining amount detecting device (AE-16)	A*

\*Only applicable to the machine with a 1.6 fold-capacity hook

Control box **SC922B**

Operation panel

**CP18C**  
**CP180C**

Power supply	Code
Single-phase 100-120V	S
3-phase 200-240V	D
Single-phase 200-240V (for general export)	K
Single-phase 200-240V (for ce)	N
Single-phase 200-240V (for china)	U

# SPECIFICATIONS

Model name	LU-2210N-7 LU-2210W-7	LU-2212N-7	LU-2220N-7	LU-2260N-7 LU-2260W-7
	1-needle	1-needle / 2-pitch dial type	1-needle / 2-pitch dial / Shorter thread remaining type	2-needle
Max. sewing speed	3,500sti/min*			
Max. stitch length	9mm (forward/backward)			6mm (forward/backward)
Needle bar stroke	33.8mm			
Max. lift of the presser foot	Auto: 16mm, By hand: 9mm			
Alternating vertical movement	1mm~6.5mm (by dial)			
Thread take-up	Link type			
Hook	N: Vertical-axis 1.6 fold-capacity hook W: Vertical-axis double-capacity hook	N: Vertical-axis 1.6 fold-capacity hook		N: Vertical-axis 1.6 fold-capacity hook W: Vertical-axis double-capacity hook
Needle	134×35R (Nm140) Nm110~Nm160			
Thread	#30~#4, B46~B138, Nm60/3~20/3			#20~#5, B64~B138, Nm40/3~20/3
Distance from needle to machine arm	263.5mm			
Lubrication	Automatic			
Bobbin thread winder	Built on the machine head			
Safety mechanism	Provided as standard			
Automatic reverse feed function	Provided as standard			
Auto-lifter	Provided as standard (pneumatic auto-lifter)			
Compressed air	0.5MPa			
Air consumption	0.763dm <sup>3</sup> /min (ANR)	1.078dm <sup>3</sup> /min (ANR)	1.337dm <sup>3</sup> /min (ANR)	0.736dm <sup>3</sup> /min (ANR)
Weight of the machine head	55kg			58kg
Power requirement	Single phase 100~120V, 200~240V 3-phase 200~240V			
Power consumption	425VA			

\* "sti/min" stands for "Stitches per Minute"

**VIET LECO, LTD.**  
Sewing & Textile machines and Parts  
HOTLINE: 0982 085 899

**JUKI ECO PRODUCTS** | The LU-2200N Series is an eco-friendly product which complies with JUKI ECO PRODUCTS standards for protecting the environment



- The sewing machine complies with the "Juki Group Green Procurement Guidelines" on the use of hazardous substances, which is stricter than other restrictions, such as those of the RoHS Directive.

For details of JUKI ECO PRODUCTS, refer to: [http://www.juki.co.jp/eco\\_e/index.html](http://www.juki.co.jp/eco_e/index.html)

\*The RoHS Directive is an EU Directive limiting the use of 6 hazardous substances (lead, hexavalent chromium, mercury, cadmium, PBB and PBDE) in electrical and electronic equipment. The Juki Green Procurement Guideline is the voluntarily established criteria to eliminate not only the aforementioned six substances, but also other ones which also adversely affect the environment.



2-11-1, TSURUMAKI, TAMA-SHI,  
TOKYO 206-8551, JAPAN  
PHONE : (81) 42-357-2254  
FAX : (81) 42-357-2274  
<http://www.juki.com>



Registered Organization : JUKI CORPORATION Head Office  
The Scope of the Registration : The activities of research, development, design, sales, distribution, and maintenance services of industrial sewing machines, household sewing machines and industrial robots, etc., including sales and maintenance services of data entry systems.

\* Specifications and appearance are subject to change without prior notice for improvement.  
\* Read the instruction manual before putting the machine into service to ensure safety.  
\* This catalogue prints with environment-friendly soy ink on recycle paper.